

HAFEX[®]

K-TYPE

HFX-3400

DATA SHEET

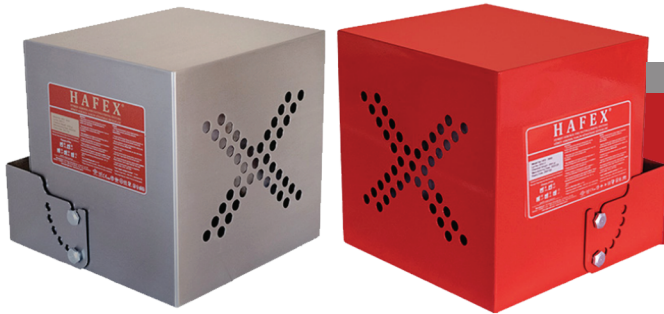

HFX-3400

MODEL NAME :	HFX-3400
GROSS WEIGHT :	20400 gr ±%3
CHEMICAL WEIGHT :	3400 gr. POTASSIUM NITRATE
COOLING SECTION WEIGHT :	6800 gr. ±%5 (PRP:%99 Al ₂ O ₃ , 16mm Ø Melting Point 2050°C)
HIGH TEMPERATURE INSULATION FELT :	5 pcs. 3mm(d),(1800°C)
DIMENSIONS :	287 x 287 x 264 (in mm.)
MARKING METHOD :	Screen Printing (Serigraph)
CASING MATERIAL :	STAINLESS STEEL/PAINTED STEEL

APPROVALS



TS ISO 15779



ISO 15779

CE 2806

TS EN 15276



TS EN 15276



ATEX



0437/24

bsi
Aerosol
Fire
Extinguishers
KITEMARK™

BS EN 15276 (BSI KITEMARK)

MED - IMO MSC.1/Circ.1270 (WHEELMARK)

ATEX (EX-PROOF MARK)

DISCHARGE CHARACTERISTICS OF HAFX CONDENSED AEROSOL GENERATORS

MODEL NAME	75°C DISTANCE (m)	200°C DISTANCE (m)	400°C DISTANCE (m)	DISCHARGE TIME (sec)
HFX - 3400	1.50	0.30	-	14-17

WALL INSTALLATION

HFX-3400 WALL INSTALLATION

- 1. AEROSOL BODY
- 2. HANGING APPARATUS
- 3. IGNITER/ACTIVATOR
- 4. SCREW
- 5. NUT BOLT
- 6. BOLT
- 7. INSTALLATION WALL

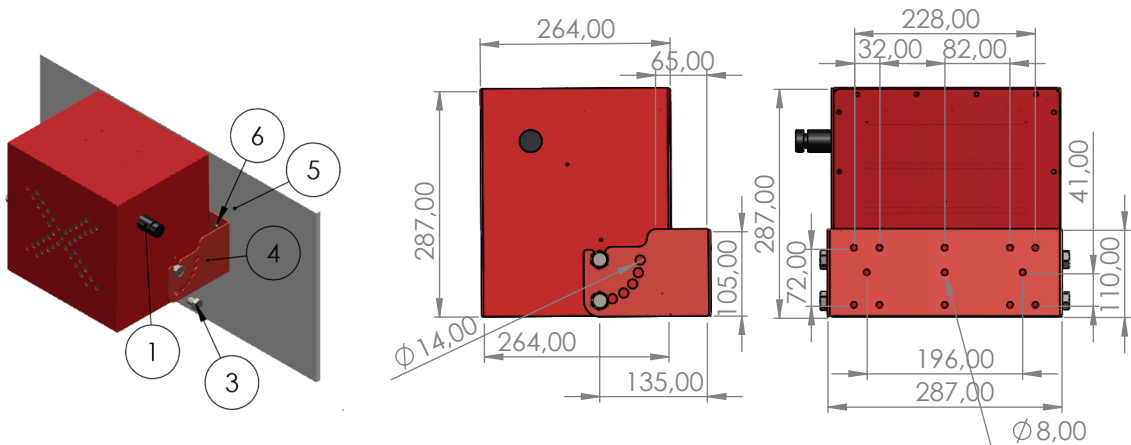
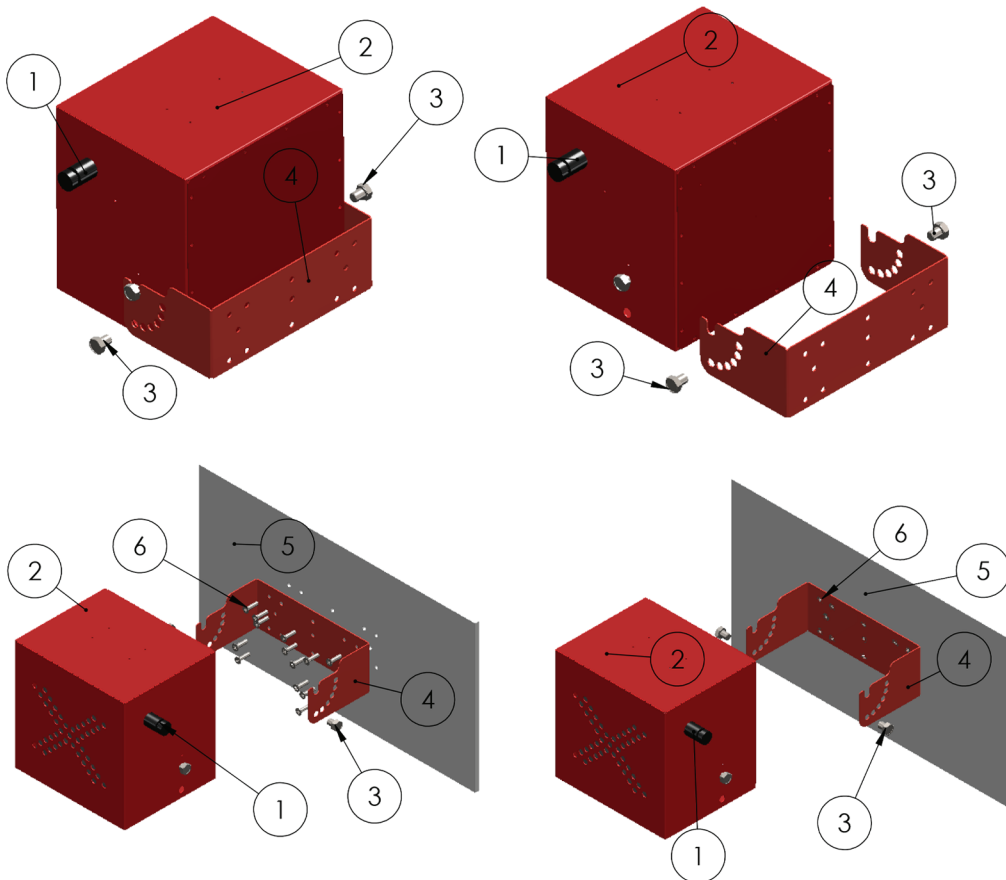

CEILING INSTALLATION

HFX-3400 CEILING INSTALLATION

- 1. AEROSOL BODY
- 2. HANGING APPARATUS
- 3. IGNITER/ACTIVATOR
- 4. SCREW
- 5. NUT BOLT
- 6. BOLT
- 7. INSTALLATION WALL

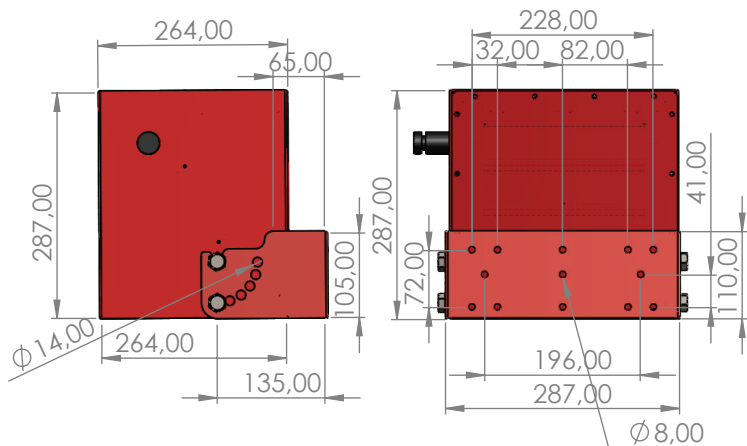
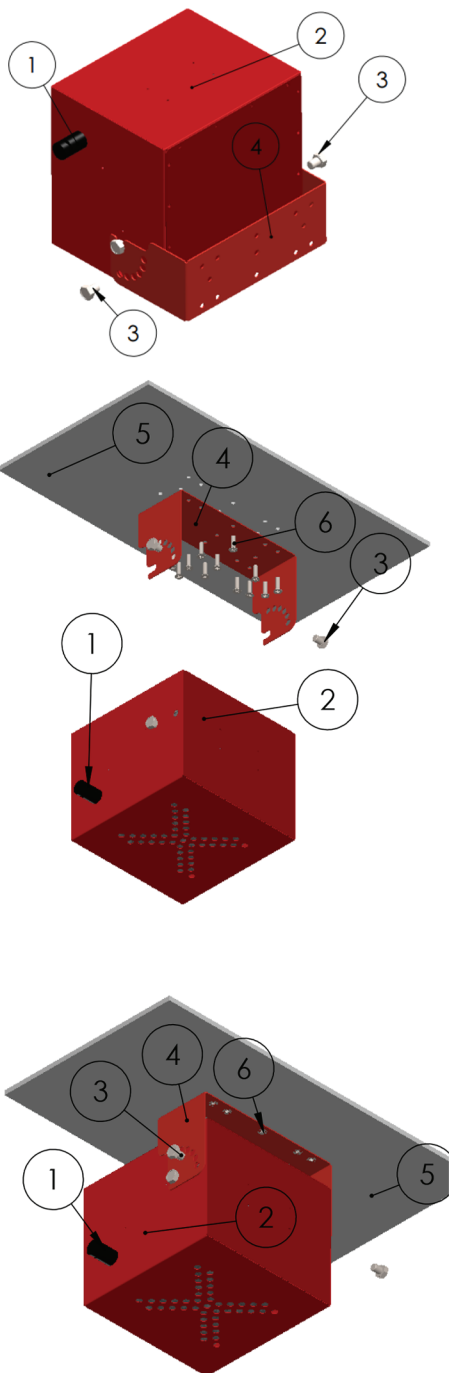

ANGLE OPTIONS

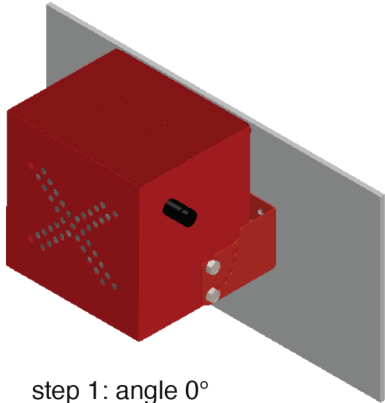

step 1: angle 0°

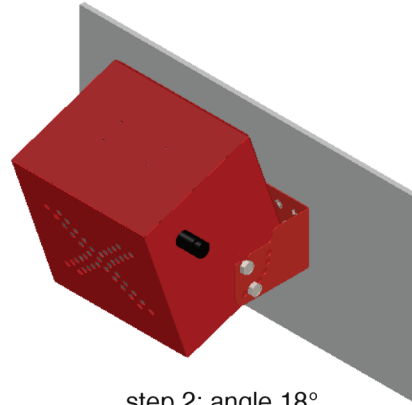

step 2: angle 18°

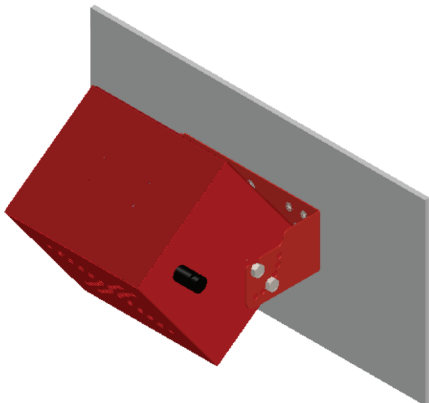

step 3: angle 36°

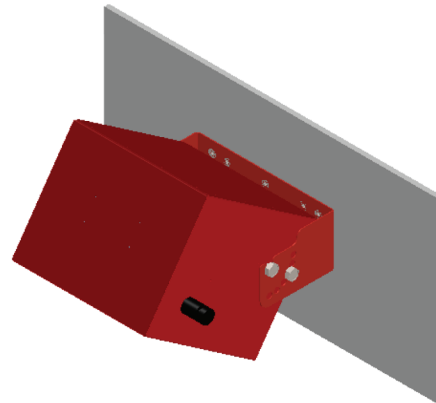

step 4: angle 54°

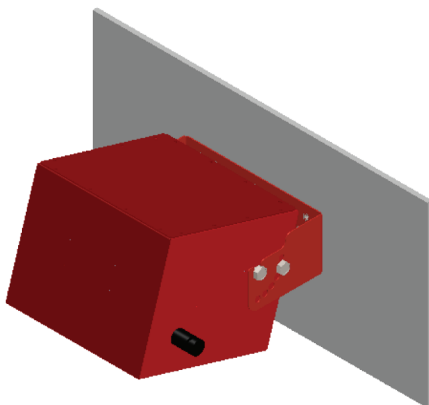

step 5: angle 72°

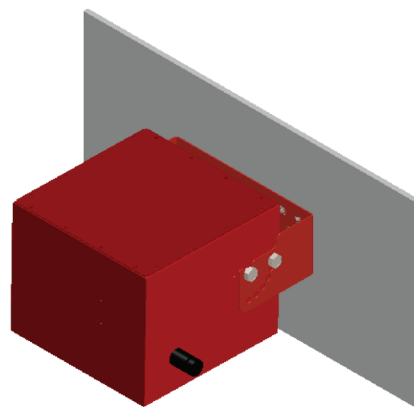

step 6: angle 90°

WARNING: IF THE ANGLE OF THE DISCHARGE PATH IS REQUIRED TO BE CHANGED, REMOVE THE SCREWS THEN TURN THE AEROSOL BODY TO THE CORRECT ANGLE AND TIGHTEN THE SCREWS WHICH WERE REMOVED.



YG FIRE SECURITY
INDUSTRY AND
FOREIGN TRADE
LIMITED COMPANY

4. Levent Sanayi Bölgesi,
Yeşilce Mahallesi,
Demirbas Sokak No:20
Kagithane
İstanbul
TÜRKİYE

T +90 212 210 62 06
F +90 212 210 62 07

INTERNATIONAL CALLS
(GSM & WhatsApp)
+90 546 500 24 05

E info@hafex.com.tr
info@ygyangin.com

Europe Office
HAFEX EU s.r.o
Revoluční 1403/28,
Nové Město,
110 00 Praha 1
Czech Republic

E info@hafex.eu